

FEATURES

- 10.2kV Isolation
- 10 μ s Short Circuit Withstand
- High Thermal Cycling Capability
- Soft Punch Through Silicon
- Isolated AISiC Base With AlN Substrates
- Lead Free Construction

APPLICATIONS

- High Reliability Inverters
- Motor Controllers
- Traction Drives
- Choppers

The Powerline range of high power modules includes half bridge, chopper, dual, single and bi-directional switch configurations covering voltages from 1200V to 6500V and currents up to 2400A.

The DIM1200ASM33-F000 is a single switch 3300V, n-channel enhancement mode, insulated gate bipolar transistor (IGBT) module. The IGBT has a wide reverse bias safe operating area (RBSOA) plus 10 μ s short circuit withstand. This device is optimised for traction drives and other applications requiring high thermal cycling capability.

The module incorporates an electrically isolated base plate and low inductance construction enabling circuit designers to optimise circuit layouts and utilise grounded heat sinks for safety.

ORDERING INFORMATION

Order As:

DIM1200ASM33-F000

Note: When ordering, please use the complete part number

KEY PARAMETERS

V_{CES}	3300V
$V_{CE(sat)}$ * (typ)	2.8V
I_C (max)	1200A
$I_{C(PK)}$ (max)	2400A

* Measured at the auxiliary terminals

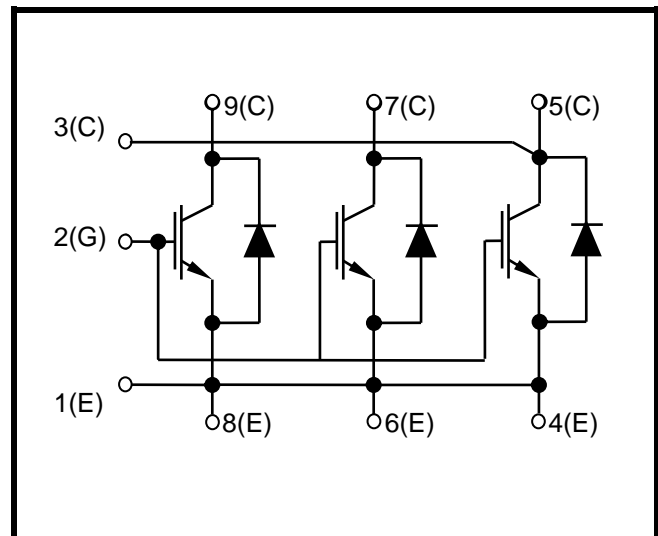

Fig. 1 Circuit configuration



Outline type code: A
(See Fig. 11 for further information)

Fig. 2 Package

ABSOLUTE MAXIMUM RATINGS

Stresses above those listed under ‘Absolute Maximum Ratings’ may cause permanent damage to the device. In extreme conditions, as with all semiconductors, this may include potentially hazardous rupture of the package. Appropriate safety precautions should always be followed. Exposure to Absolute Maximum Ratings may affect device reliability.

T_{case} = 25°C unless stated otherwise

Symbol	Parameter	Test Conditions	Max.	Units
V _{CES}	Collector-emitter voltage	V _{GE} = 0V	3300	V
V _{GES}	Gate-emitter voltage		±20	V
I _C	Continuous collector current	T _{case} = 90°C	1200	A
I _{C(PK)}	Peak collector current	1ms, T _{case} = 115°C	2400	A
P _{max}	Max. transistor power dissipation	T _{case} = 25°C, T _j = 150°C	15.6	kW
I ² t	Diode I ² t value	V _R = 0, t _p = 10ms, T _j = 125°C	720	kA ² s
V _{isol}	Isolation voltage – per module	Commoned terminals to base plate. AC RMS, 1 min, 50Hz	10.2	kV
Q _{PD}	Partial discharge – per module	IEC1287, V ₁ = 6900V, V ₂ = 5100V, 50Hz RMS	10	pC

THERMAL AND MECHANICAL RATINGS

Internal insulation material: AIN
 Baseplate material: AISiC
 Creepage distance: 56mm
 Clearance: 26mm
 CTI (Comparative Tracking Index): >600

Symbol	Parameter	Test Conditions	Min	Typ.	Max	Units
R _{th(j-c)}	Thermal resistance – transistor	Continuous dissipation - junction to case	-	-	8	°C/kW
R _{th(j-c)}	Thermal resistance – diode	Continuous dissipation - junction to case	-	-	16	°C/kW
R _{th(c-h)}	Thermal resistance – case to heatsink (per module)	Mounting torque 5Nm (with mounting grease)	-	-	6	°C/kW
T _j	Junction temperature	Transistor	-	-	150	°C
		Diode	-	-	125	°C
T _{stg}	Storage temperature range	-	-40	-	125	°C
	Screw torque	Mounting – M6	-	-	5	Nm
		Electrical connections – M4	-	-	2	Nm
		Electrical connections – M8	-	-	10	Nm

ELECTRICAL CHARACTERISTICS

$T_{case} = 25^{\circ}C$ unless stated otherwise.

Symbol	Parameter	Test Conditions	Min	Typ	Max	Units
I_{CES}	Collector cut-off current	$V_{GE} = 0V, V_{CE} = V_{CES}$			5	mA
		$V_{GE} = 0V, V_{CE} = V_{CES}, T_{case} = 125^{\circ}C$			90	mA
I_{GES}	Gate leakage current	$V_{GE} = \pm 20V, V_{CE} = 0V$			1	μA
$V_{GE(TH)}$	Gate threshold voltage	$I_C = 120mA, V_{GE} = V_{CE}$	5.5	6.5	7.0	V
$V_{CE(sat)}$	Collector-emitter saturation voltage	$V_{GE} = 15V, I_C = 1200A$		2.8		V
		$V_{GE} = 15V, I_C = 1200A, T_j = 125^{\circ}C$		3.6		V
I_F	Diode forward current	DC		1200		A
I_{FM}	Diode maximum forward current	$t_p = 1ms$		2400		A
V_F	Diode forward voltage	$I_F = 1200A$		2.9		V
		$I_F = 1200A, T_j = 125^{\circ}C$		3.0		V
C_{ies}	Input capacitance	$V_{CE} = 25V, V_{GE} = 0V, f = 1MHz$		216		nF
Q_g	Gate charge	$\pm 15V$		30		μC
C_{res}	Reverse transfer capacitance	$V_{CE} = 25V, V_{GE} = 0V, f = 1MHz$		3.3		nF
L_M	Module inductance			10		nH
R_{INT}	Internal transistor resistance			90		$\mu\Omega$
SC_{Data}	Short circuit current, I_{SC}	$T_j = 125^{\circ}C, V_{CC} = 2500V$ $t_p \leq 10\mu s, V_{GE} \leq 15V$ $V_{CE(max)} = V_{CES} - L^* \times dl/dt$ IEC 60747-9		5500		A

Note:

* L is the circuit inductance + L_M

ELECTRICAL CHARACTERISTICS

T_{case} = 25°C unless stated otherwise

Symbol	Parameter	Test Conditions		Min	Typ.	Max	Units
t _{d(off)}	Turn-off delay time	I _C = 1200A V _{GE} = ±15V V _{CE} = 1800V C _{ge} = 330nF L _S ~ 100nH	R _{G(ON)} = 2.7Ω R _{G(OFF)} = 4.7Ω		2150		ns
t _f	Fall time				230		ns
E _{OFF}	Turn-off energy loss				1550		mJ
t _{d(on)}	Turn-on delay time				1300		ns
t _r	Rise time				275		ns
E _{ON}	Turn-on energy loss		R _{G(ON)} = 1.65Ω R _{G(OFF)} = 4.7Ω		1850		mJ
Q _{rr}	Diode reverse recovery charge	I _F = 2400A V _{CE} = 1800V dI _F /dt = 6000A/μs			480		μC
I _{rr}	Diode reverse recovery current				1000		A
E _{rec}	Diode reverse recovery energy				450		mJ

T_{case} = 125°C unless stated otherwise

Symbol	Parameter	Test Conditions		Min	Typ.	Max	Units
t _{d(off)}	Turn-off delay time	I _C = 1200A V _{GE} = ±15V V _{CE} = 1800V C _{ge} = 330nF L _S ~ 100nH	R _{G(ON)} = 2.7Ω R _{G(OFF)} = 4.7Ω		2200		ns
t _f	Fall time				240		ns
E _{OFF}	Turn-off energy loss				1800		mJ
t _{d(on)}	Turn-on delay time				1200		ns
t _r	Rise time				315		ns
E _{ON}	Turn-on energy loss		R _{G(ON)} = 1.65Ω R _{G(OFF)} = 4.7Ω		2600		mJ
Q _{rr}	Diode reverse recovery charge	I _F = 1200A V _{CE} = 1800V dI _F /dt = 6000A/μs			900		μC
I _{rr}	Diode reverse recovery current				1200		A
E _{rec}	Diode reverse recovery energy				900		mJ

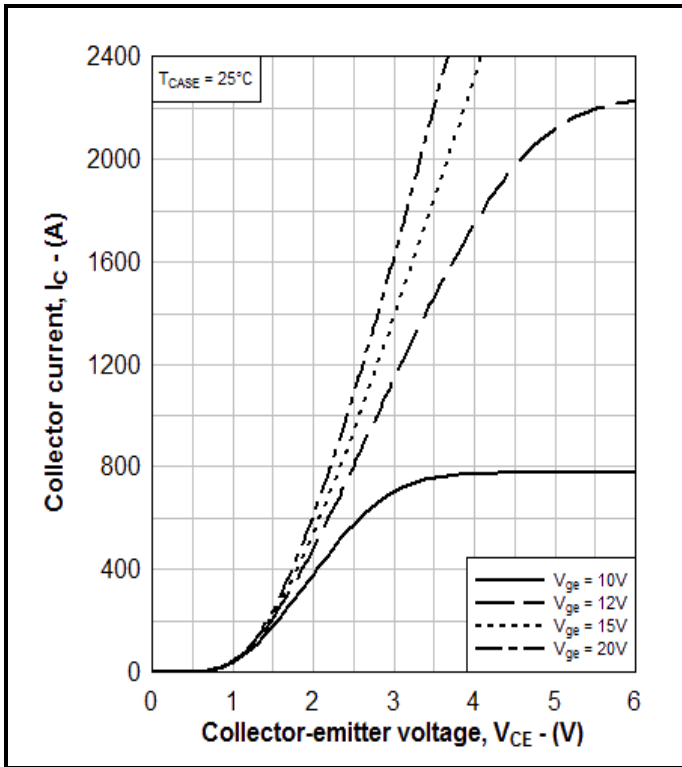

Fig. 3 Typical output characteristics

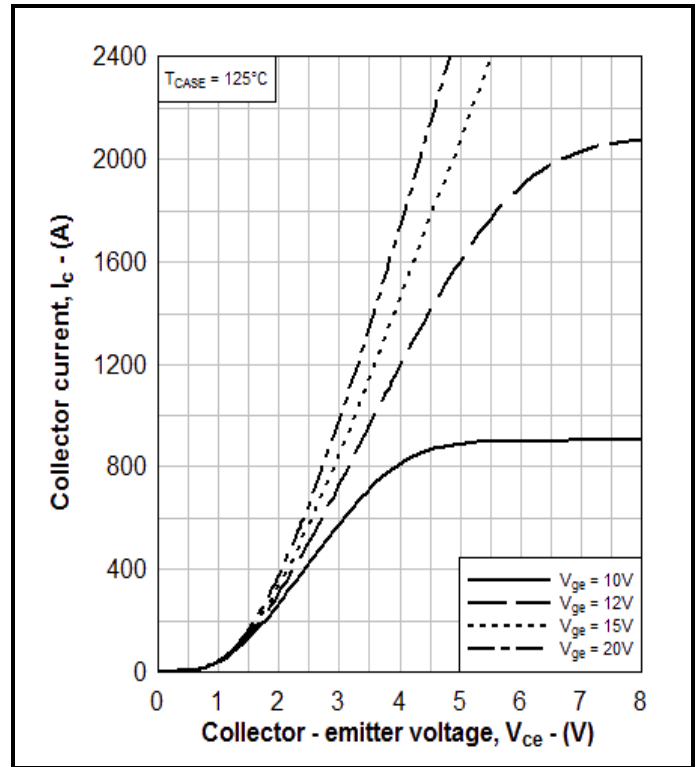

Fig. 4 Typical output characteristics

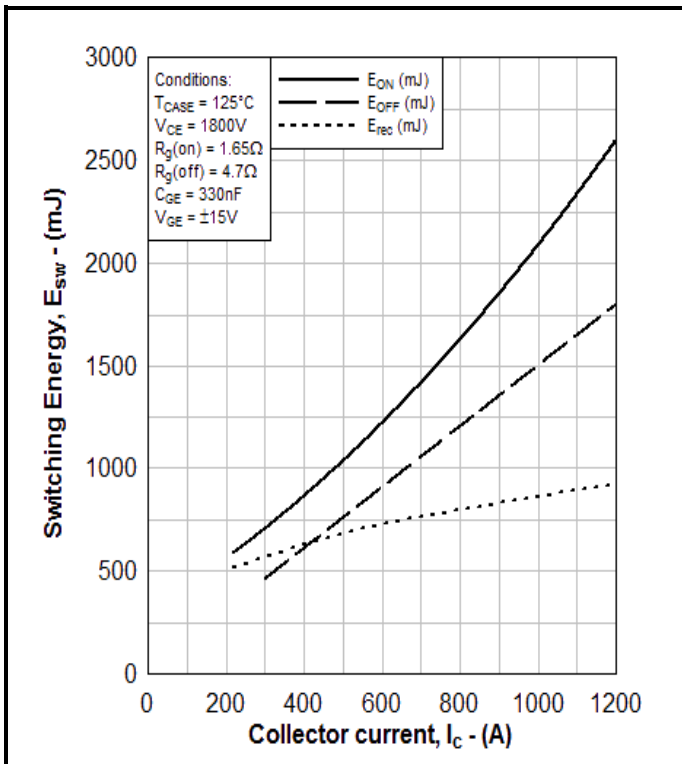

Fig. 5 Typical switching energy vs collector current

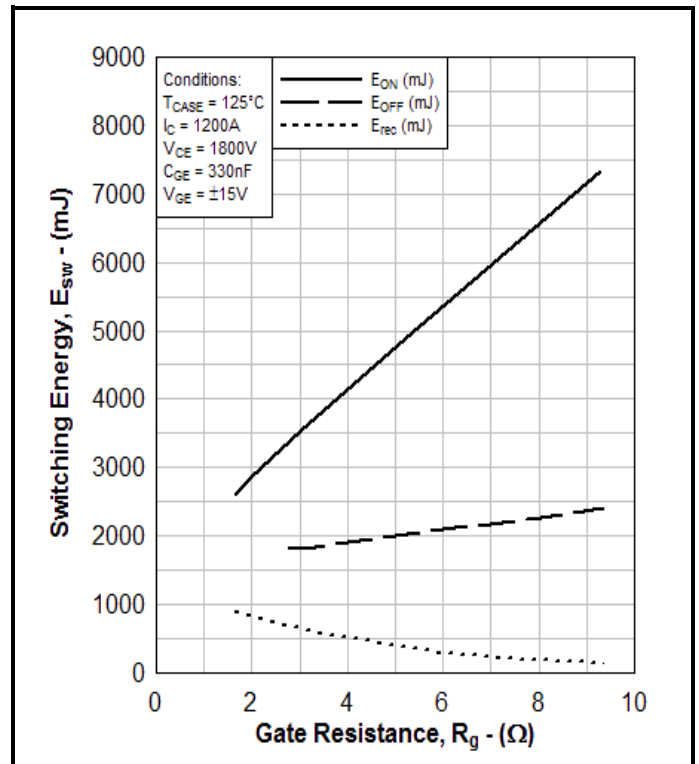

Fig. 6 Typical switching energy vs gate resistance

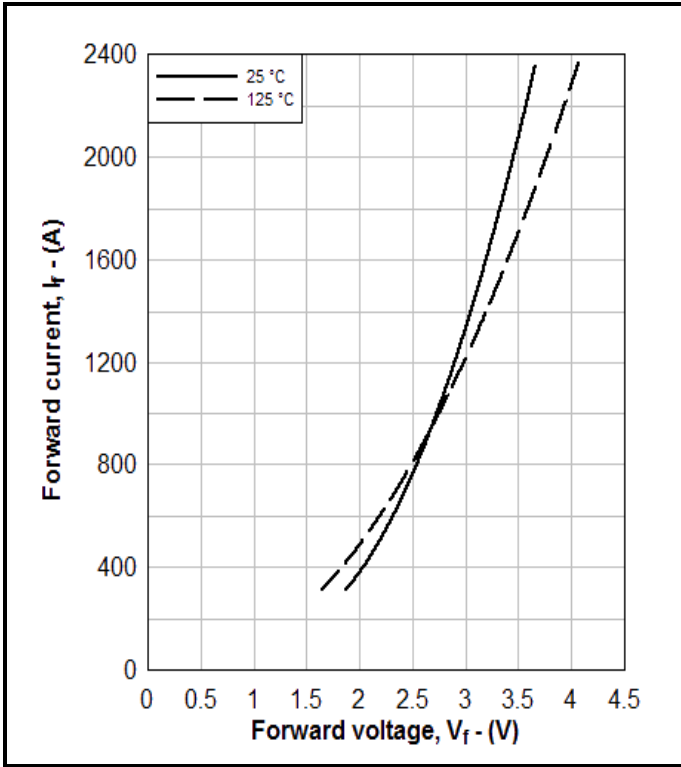

Fig. 7 Diode typical forward characteristics

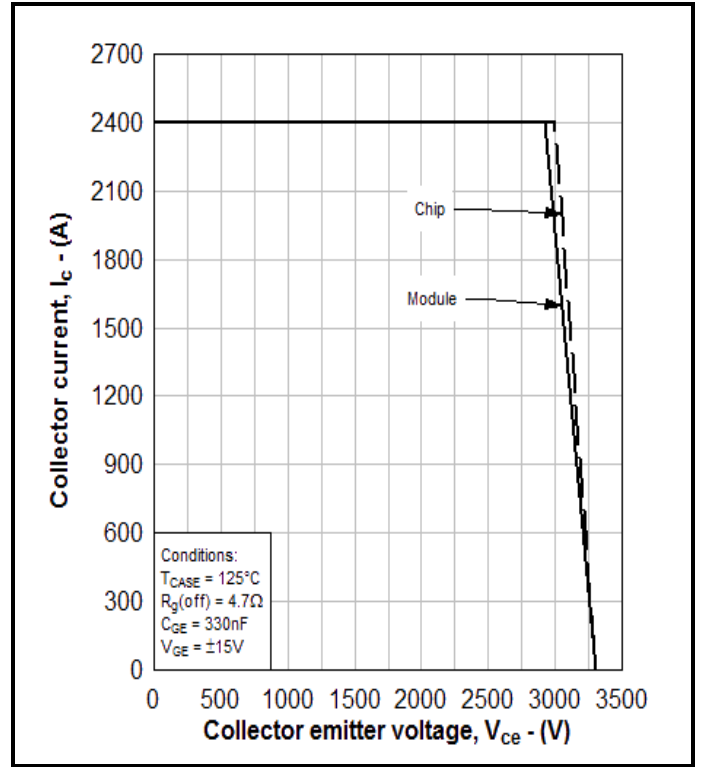

Fig. 8 Reverse bias safe operating area

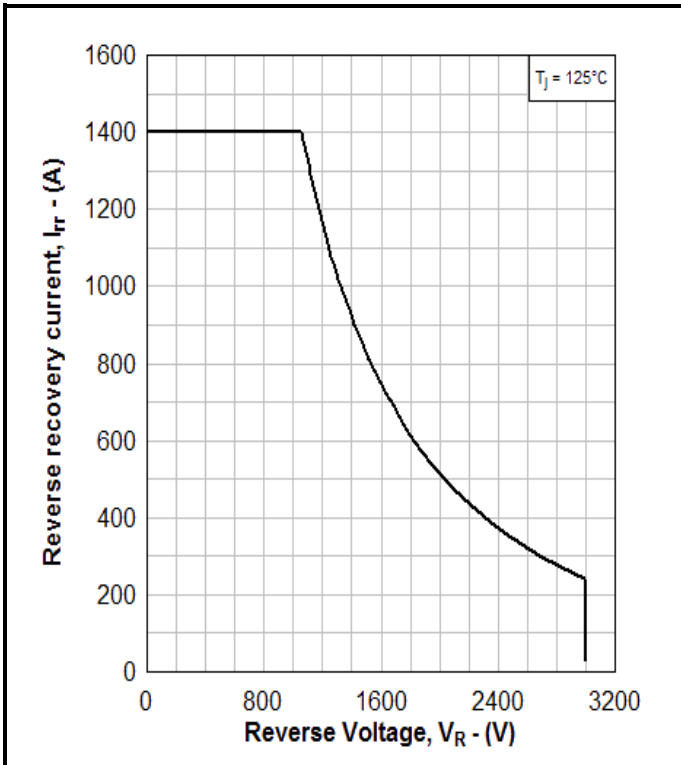

Fig. 9 Diode reverse bias safe operating area

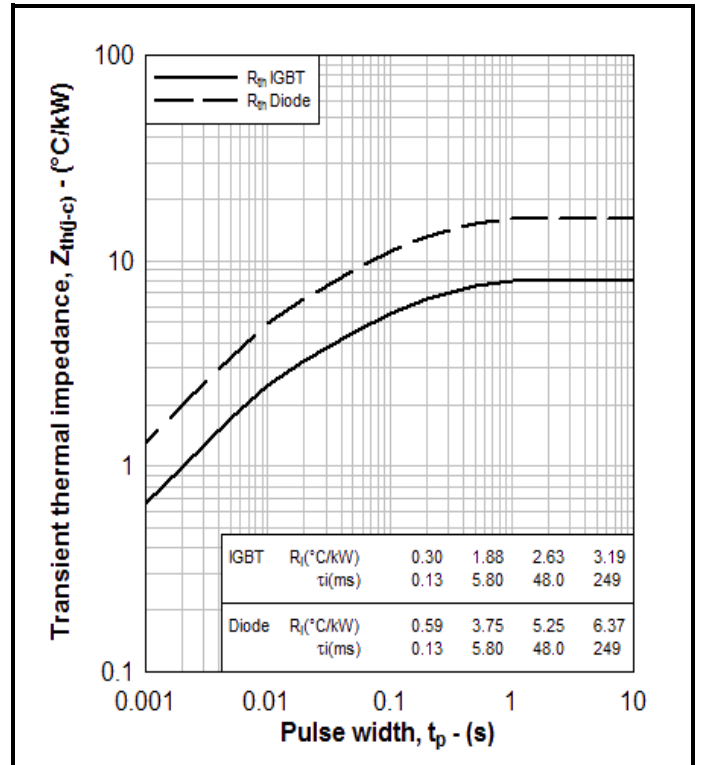

Fig. 10 Transient thermal impedance

PACKAGE DETAILS

For further package information, please visit our website or contact Customer Services.
 All dimensions in mm, unless stated otherwise.
DO NOT SCALE.

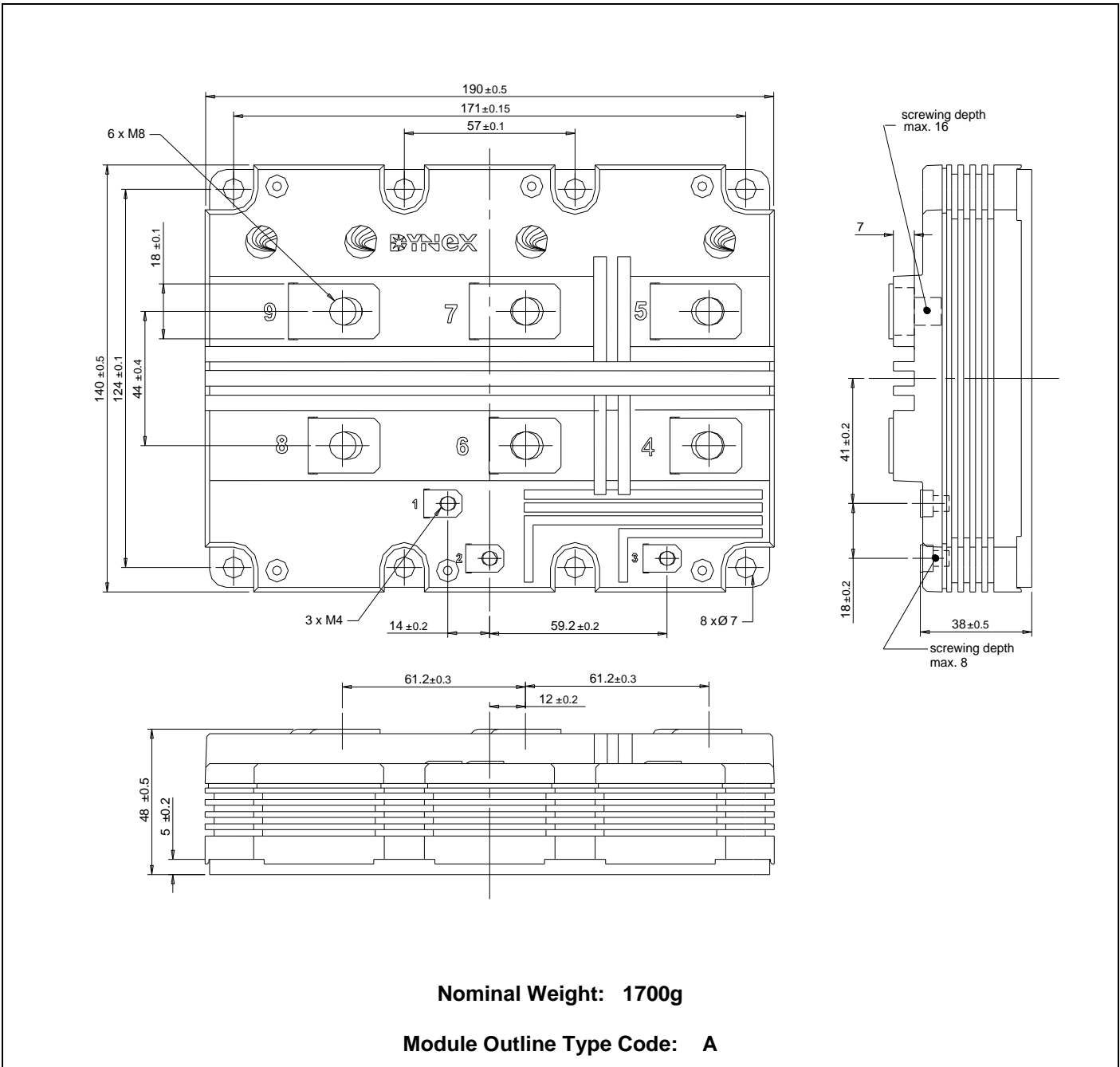

Fig. 11 Module outline drawing

IMPORTANT INFORMATION:

This publication is provided for information only and not for resale.

The products and information in this publication are intended for use by appropriately trained technical personnel.

Due to the diversity of product applications, the information contained herein is provided as a general guide only and does not constitute any guarantee of suitability for use in a specific application. The user must evaluate the suitability of the product and the completeness of the product data for the application. The user is responsible for product selection and ensuring all safety and any warning requirements are met. Should additional product information be needed please contact Customer Service.

Although we have endeavoured to carefully compile the information in this publication it may contain inaccuracies or typographical errors. The information is provided without any warranty or guarantee of any kind.

This publication is an uncontrolled document and is subject to change without notice. When referring to it please ensure that it is the most up to date version and has not been superseded.

The products are not intended for use in applications where a failure or malfunction may cause loss of life, injury or damage to property. The user must ensure that appropriate safety precautions are taken to prevent or mitigate the consequences of a product failure or malfunction.

The products must not be touched when operating because there is a danger of electrocution or severe burning. Always use protective safety equipment such as appropriate shields for the product and wear safety glasses. Even when disconnected any electric charge remaining in the product must be discharged and allowed to cool before safe handling using protective gloves.

Extended exposure to conditions outside the product ratings may affect reliability leading to premature product failure. Use outside the product ratings is likely to cause permanent damage to the product. In extreme conditions, as with all semiconductors, this may include potentially hazardous rupture, a large current to flow or high voltage arcing, resulting in fire or explosion. Appropriate application design and safety precautions should always be followed to protect persons and property.

Product Status & Product Ordering:

We annotate datasheets in the top right hand corner of the front page, to indicate product status if it is not yet fully approved for production. The annotations are as follows:-

Target Information:	This is the most tentative form of information and represents a very preliminary specification. No actual design work on the product has been started.
Preliminary Information:	The product design is complete and final characterisation for volume production is in progress. The datasheet represents the product as it is now understood but details may change.
No Annotation:	The product has been approved for production and unless otherwise notified by Dynex any product ordered will be supplied to the current version of the data sheet prevailing at the time of our order acknowledgement.

All products and materials are sold and services provided subject to Dynex's conditions of sale, which are available on request.

Any brand names and product names used in this publication are trademarks, registered trademarks or trade names of their respective owners.

HEADQUARTERS OPERATIONS

DYNEX SEMICONDUCTOR LTD

Doddington Road, Lincoln, Lincolnshire, LN6 3LF,
United Kingdom

Fax: +44(0)1522 500550

Tel: +44(0)1522 500500

Web: <http://www.dynexsemi.com>

CUSTOMER SERVICE

DYNEX SEMICONDUCTOR LTD

Doddington Road, Lincoln, Lincolnshire, LN6 3LF,
United Kingdom

Tel: +44(0)1522 502753 / 502901

Email: powersolutions@dynexsemi.com